

SWEEPING AUGER



SWEEPING AUGER

FUNCTIONAL DESCRIPTION

Designed for handling of lighter density non free flowing bulk materials such as Wood Chips, Bark, Plastics, Auto Fluff, Animal Meal, Shredded Tires, Quick Lime, Biomass, Sewage Sludge, Bypass Dust, Coal, etc.

This powerful adaptable reclaiming is installed in the center of the silo and mounted with its built-in adapter into the silo's concrete or steel floor. It can be designed for installation in new silos or retrofitted into an existing silo and is capable of discharging from 0 to 300 m³/h. While rotating and revolving, the auger conveys the bulk material to the center of the silo where the discharge opening is located.

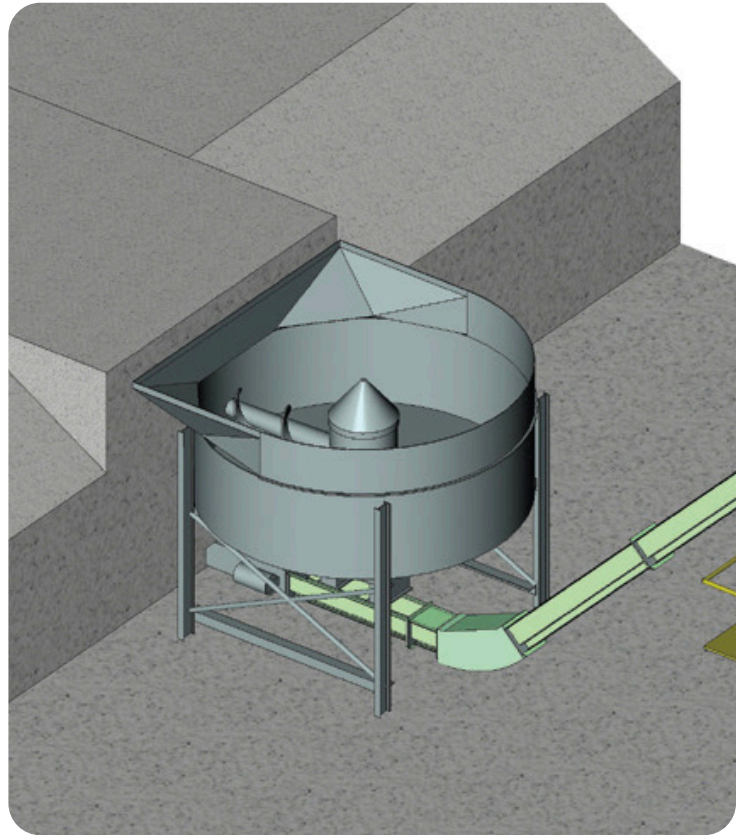

WHO WE ARE

At WTW Americas, we lead the industry in designing precision-engineered, heavy-duty bulk material handling equipment. In partnership with **Gecos GmbH**, our German-engineered solutions deliver unmatched reliability and operational efficiency to industries like cement, power, mining, and environmental sectors, making us the trusted choice for advanced material handling challenges.

SPECIAL FEATURES

- ▶ Tapered heavy-duty shaft, designed as a beam of uniform strength, therefore no sagging of the auger
- ▶ No additional support roller at the auger's tip, consequently no additional moving parts that have to be maintained
- ▶ No additional support beam behind the auger, therefore the complete auger volume is used for the discharge and reduces the horse power requirement
- ▶ Running in two bearings, increases the lifetime of the drive system
- ▶ Varying auger flight liners due to application requirement, increases the lifetime of the auger
- ▶ Long lasting heat treated tear-teeth on the auger's flights for compacted bulk material
- ▶ Heavy duty helical beveled direct drive pinions for the rotating drive to increase lifetime of the sweeping auger with no wear parts like belts, chains or sprockets
- ▶ Torque controlled revolving drive, to avoid compacting of the bulk material when conveying to the centre

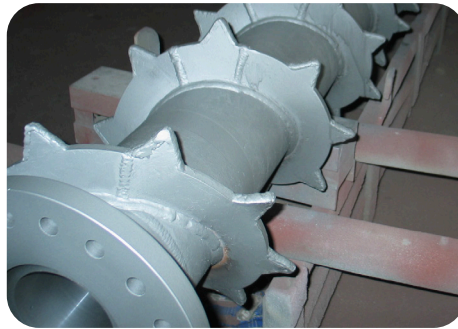
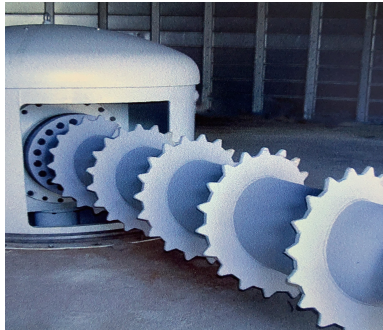
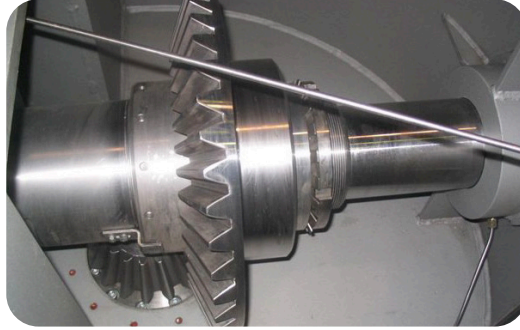
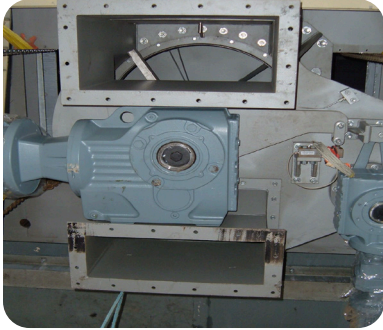

TECHNICAL DATA

Silo Diametre (mm)	SAS 1 up to 4000	SAS 2 up to 7000	SAS 3 up to 11000	SAS 4 up to 20000
A	Adaptable to clients requirements regarding thickness of silo bottom			
B	310	460	480	750
C minimum	280	450	500	830
D	Depending on SAS capacity			
E	280	430	460	850
F	240	350	420	800
D1	710	910	1210	2150

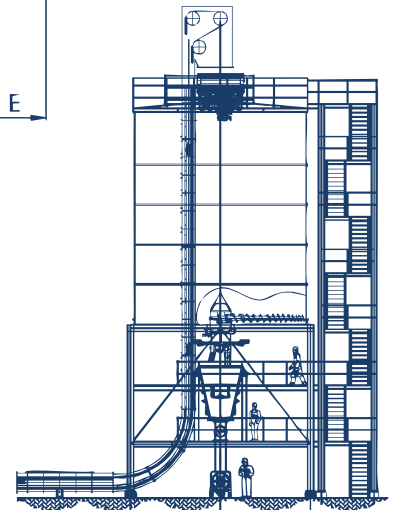
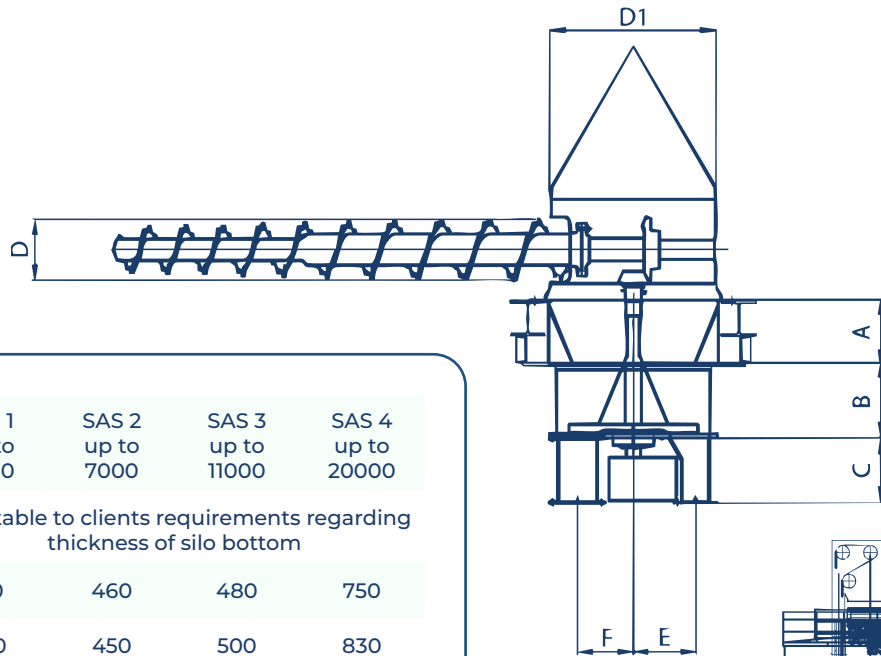

*Other sizes on request

INDUSTRIES OUR PRODUCTS ARE BUILT FOR

- GYPSUM
- CEMENT
- POWER
- ALTERNATIVE FUELS
- MINING
- CHEMICAL
- FOUNDRIES
- ENVIRONMENTAL PROTECTION
- SLUDGE & WASTE HANDLING

MORE WTW AMERICAS PRODUCTS

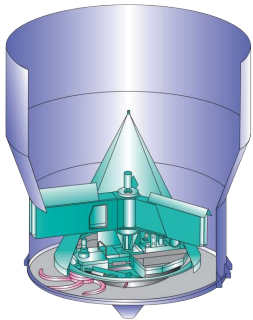

ROTARY DISCHARGE MACHINE

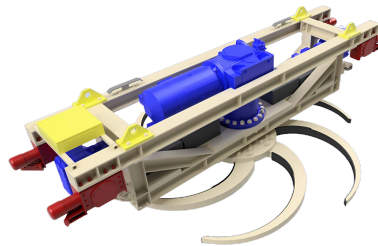

BUNKER DISCHARGE MACHINE

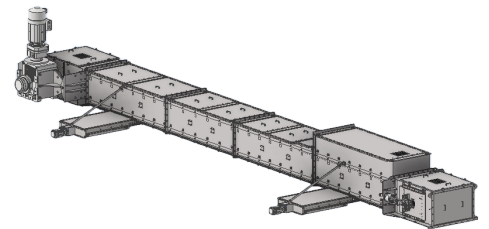

TKF CHAIN CONVEYOR

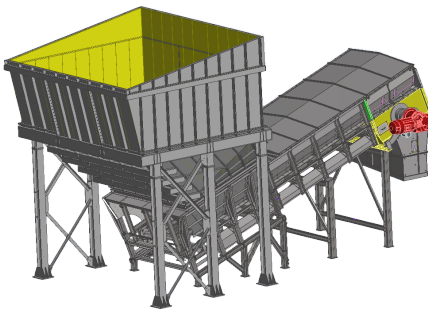

TRUCK DISCHARGE MACHINE

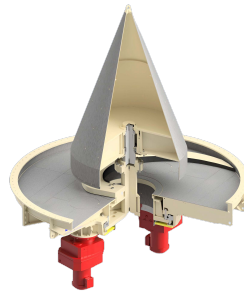

SILO DISCHARGE MACHINE

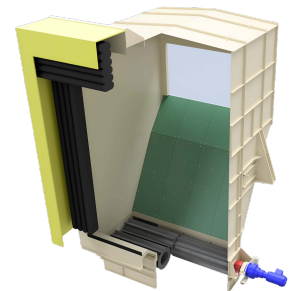

TRAILER DOCKING STATION

YOUR BULK MATERIAL HANDLING EXPERTS!

P.O. BOX 1536, PETERBOROUGH, ON CANADA • K9J 7H7